



ACOUST-IT
Acoustics in Style & Eco-Care

CATALOGUE

At Acoust-It, we combine artful design, eco-friendly innovation, and acoustic expertise to craft beautifully sustainable solutions for quieter, more harmonious, and more efficient spaces.

Leading in Technology: Innovating and Producing Nonwoven Technical Textiles for Acoustic Products

"Acoust-It" is a brand that merges technical textile expertise with decades of production and design experience, reinventing nonwoven materials to achieve outstanding acoustic performance.

High-Quality Products

Sustainability, for us, means comprehending the entire production process, supply chain, and ecological footprint. To achieve genuine sustainability, we employ recycled and recyclable raw materials, integrating unique manufacturing techniques with design and engineering to create versatile and durable products with minimal waste and low energy consumption.

Accessible comfort with Acoust-it

Acoust-It's mission is to provide accessible and effective sound control solutions that enhance the comfort and well-being of any space. Our high-performing sound-absorbing products are easy to install and offer a seamless way to create a peaceful and comfortable environment that promotes productivity, relaxation, and overall happiness. Whether you need to reduce noise in your office, home, or any other space, Acoust-It is here to offer you the perfect blend of practicality and style. We enable you to fully enjoy the spaces where you live, work, and play.

Sustainability

We are fully aware of the environmental impact that can occur during the production process. To address these concerns, we take responsibility for the entire production lifecycle, from sourcing raw materials to their proper disposal. Acoust-It remains committed to its sustainability goals and has implemented several measures to ensure that our designs are both produced and designed with sustainability in mind.

We understand the versatility and value of PET plastic and the importance of diverting it from landfills while repurposing it in an environmentally responsible manner. Once collected, PET bottles are transformed into flakes and fibers, which are then used to create recycled PET felt. This innovative material plays a crucial role in our tile production process, allowing us to craft stylish and durable products while also reducing our carbon footprint.

Our dedication to sustainability goes beyond materials. We continually explore new ways to minimize our environmental impact, from refining our manufacturing processes to reducing energy consumption. With a comprehensive approach to sustainability, we aim to create a more sustainable future for everyone.

Advanced Sound-Absorbing Features

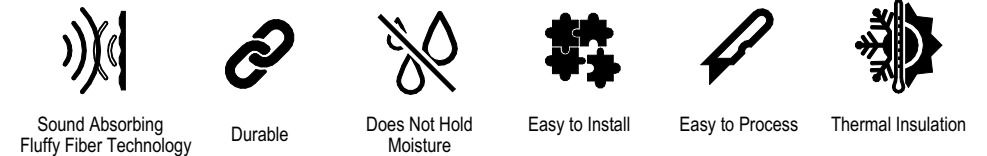

Eco-Friendly & Safe



Stylish & Versatile Design

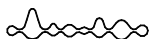
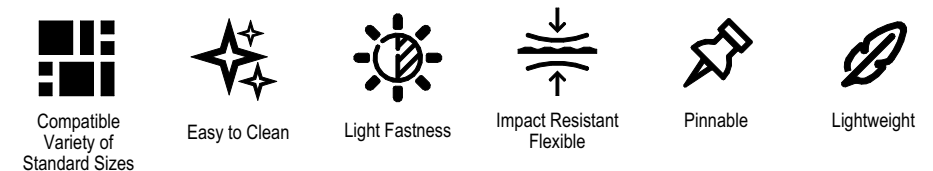

Mix & Match

Dimensions and design of all ACOUST-IT products are compatible with each other. This compatibility allows for the creation of unique and diverse combinations. To customize your order according to your preferences, you can select combinations based on box quantities and colors

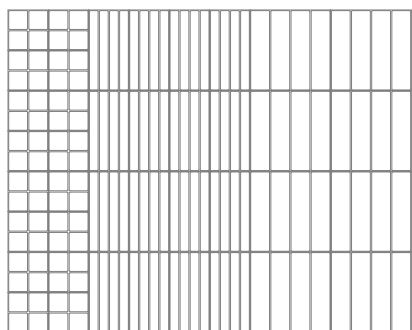

Plaid Ridge Bold

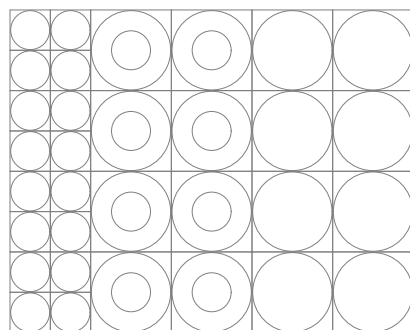

Moon Saturn Venus

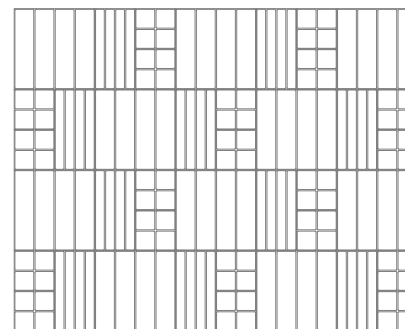

Bold - Ridge - Plaid

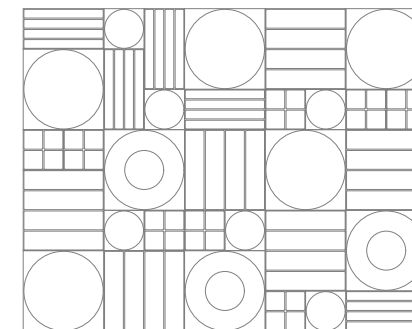

Bold - Ridge - Plaid - Saturn - Venus - Moon

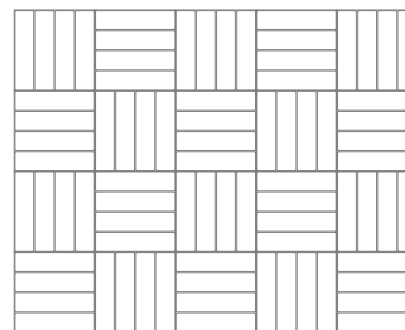

Bold

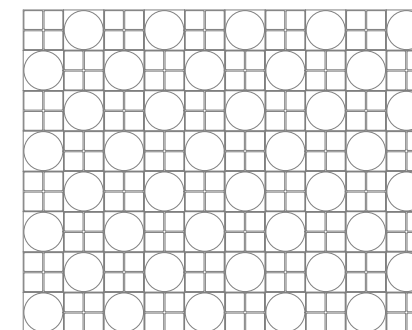

Plaid - Moon

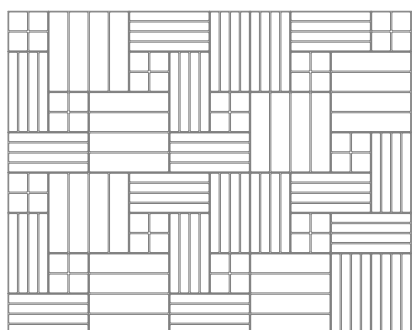

Plaid - Ridge - Bold

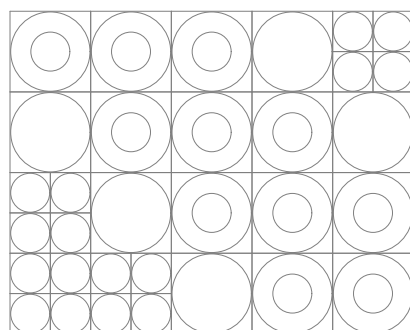

Moon - Saturn - Venus

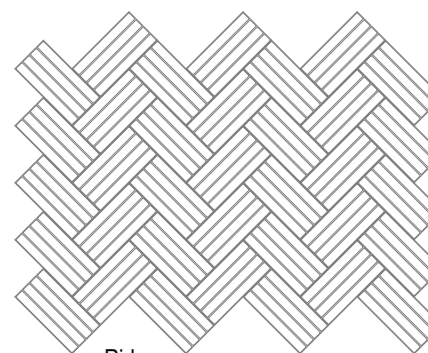

Ridge

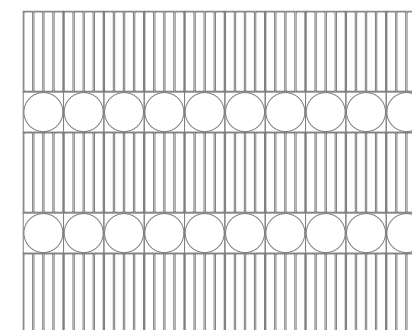

Ridge - Moon

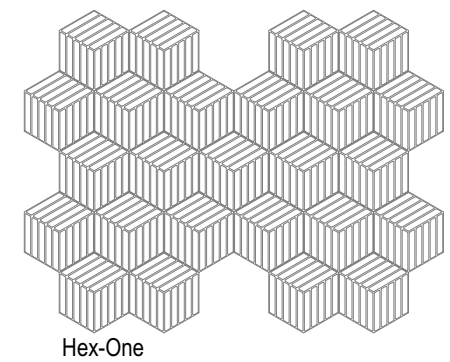
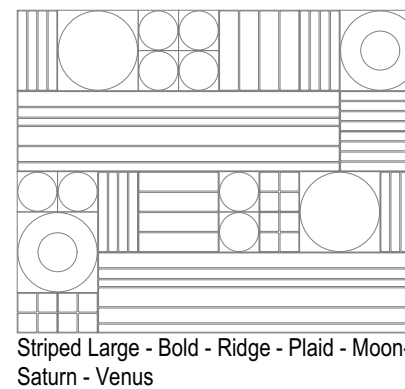
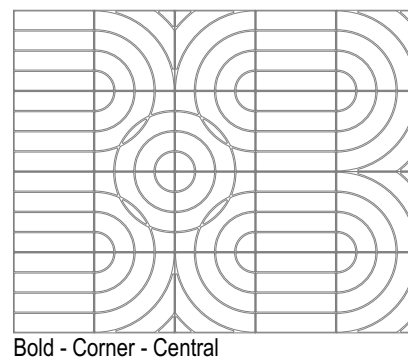
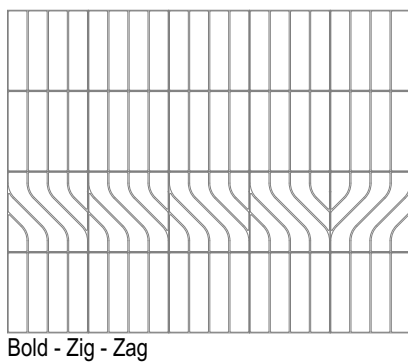
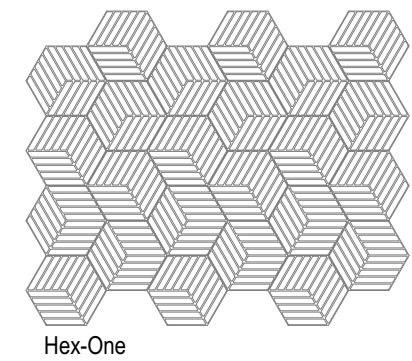
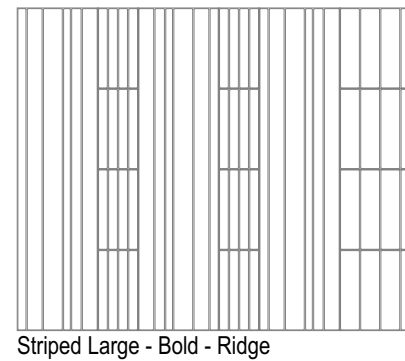
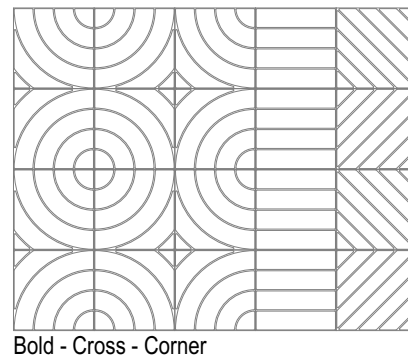
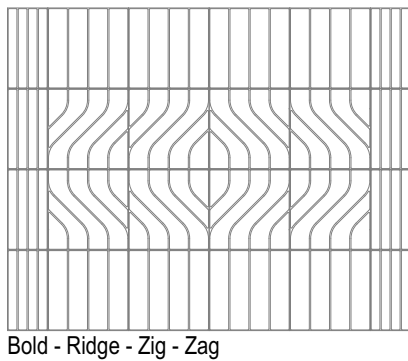
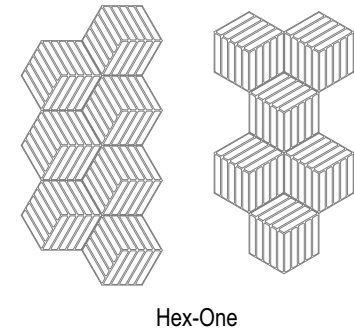
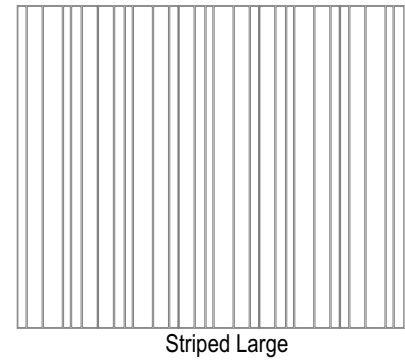
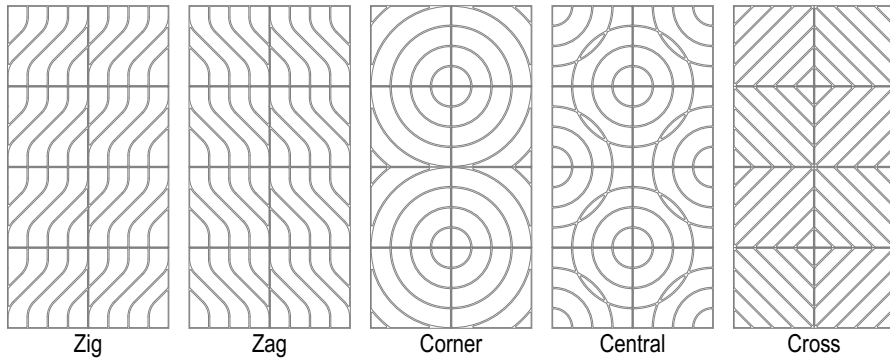

Wall Panel
Plaid

Ridge

Bold



Plaid

APPLICATION

Internal Acoustic Control & Decorative Wall Panel
 Assembly Adhesive or Self Adhesived
 Double-Sided Tape Included For Installation

DIMENSIONS

W: 300mm (+/- 1mm) L: 300mm (+/- 1mm)
 W: 11.81" (+/-0.05") L: 11.81" (+/-0.05")

THICKNESS

Max. 13mm (+/- 2mm) - 0.51" (+/-0.08")
 Min. 3mm (+/- 2mm) - 0.12" (+/-0.08")



Smooth Surface - Impact Resistance - Flexible

WEIGHT

1 tile: 112.5gr. +/- 10% tolerance
 1 tile: 0.25 lbs with +/- 10% tolerance

BOX SIZE & CONTENT

W: 620mm D: 620mm H: 160mm
 W: 24,41" D: 24,41" H: 6,3"
 1 Box: 40 x Tiles
 1 Box: 3.6m2 / 38.75sqft
 1 Color of choice per package
 Gross weight: 5.2Kg - 11.5 lbs

MATERIAL

Mechanical needled punch industrial felt. 100%
 PET up to 60% Recycled content & Recyclable

SOUND ABSORPTION

NRC Value 0.45 (ISO 11654)

FIRE RATING

A Class (ASTM E84) - B s1 d0 (EN 13501-1)

THERMAL INSULATION

0,035 W/mK



Product Code: PLD-20AA-BEG1091



Product Code: PLD-20AA-DGR2061

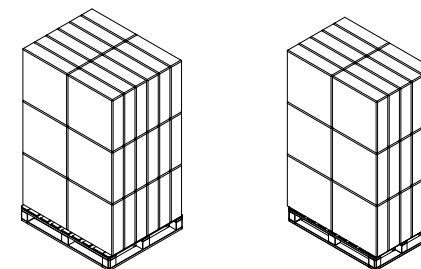

Product Code: PLD-20AA-GRY2011

PALETTE SIZES & CONTENT

W: 1200mm D: 1000mm H: 2100mm W: 48" D: 40" H: 82"	W: 1200mm D: 800mm H: 2100mm W: 48" D: 31,5" H: 82"
1 Palette: 36 Pcs. Box	1 Palette: 30 Pcs. Box
Gross weight: 204Kg - 451 lbs	Gross weight: 170Kg - 375 lbs

Ridge

APPLICATION

Internal Acoustic Control & Decorative Wall Panel
 Assembly Adhesive or Self Adhesived
 Double-Sided Tape Included For Installation

DIMENSIONS

W: 300mm (+/- 1mm) L: 600mm (+/- 1mm)
 W: 11.81" (+/-0.05") L: 23.62" (+/-0.05")

THICKNESS



Max. 10mm (+/- 2mm) - 0.39" (+/-0.08")
 Min. 3mm (+/- 2mm) - 0.12" (+/-0.08")



Smooth Surface - Impact Resistance - Flexible

WEIGHT

1 tile: 225gr. +/- 10% tolerance
 1 tile: 0.50 lbs with +/- 10% tolerance

BOX SIZE & CONTENT

W: 620mm D: 620mm H: 160mm
 W: 24,41" D: 24,41" H: 6,3"
 1 Box: 24 x Tiles
 1 Box: 4.32m² / 46.5sqft
 1 Color of choice per package
 Gross weight: 6.3Kg - 13.9 lbs

MATERIAL

Mechanical needled punch industrial felt. 100%
 PET up to 60% Recycled content & Recyclable

SOUND ABSORPTION

NRC Value 0.45 (ISO 11654)

FIRE RATING

A Class (ASTM E84) - B s1 d0 (EN 13501-1)

THERMAL INSULATION

0.035 W/mK



Product Code: RDG-20AA-BEG1091



Product Code: RDG-20AA-DGR2061



Product Code: RDG-20AA-GRY2011

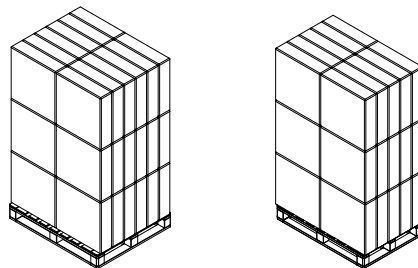

PALETTE SIZES & CONTENT

W: 1200mm D: 1000mm H: 2100mm W: 48" D: 40" H: 82"	W: 1200mm D: 800mm H: 2100mm W: 48" D: 31,5" H: 82"
1 Palette: 36 Pcs. Box	1 Palette: 30 Pcs. Box
Gross weight: 237Kg - 522 lbs	Gross weight: 197Kg - 434 lbs

Bold

APPLICATION

Internal Acoustic Control & Decorative Wall Panel
 Assembly Adhesive or Self Adhesived
 Double-Sided Tape Included For Installation

DIMENSIONS

W: 600mm (+/- 1mm) L: 600mm (+/- 1mm)
 W: 23.62" (+/-0.05") L: 23.62" (+/-0.05")

THICKNESS



Max. 13mm (+/- 2mm) - 0.51" (+/-0.08")
 Min. 3mm (+/- 2mm) - 0.12" (+/-0.08")



Smooth Surface - Impact Resistance - Flexible

WEIGHT

1 tile: 450gr. +/- 10% tolerance
 1 tile: 1.00 lbs with +/- 10% tolerance

BOX SIZE & CONTENT

W: 620mm D: 620mm H: 160mm
 W: 24,41" D: 24,41" H: 6,3"
 1 Box: 10 x Tiles
 1 Box: 3.6m² / 38.75sqft
 1 Color of choice per package
 Gross weight: 5.2Kg - 11.5 lbs

MATERIAL

Mechanical needled punch industrial felt. 100%
 PET up to 60% Recycled content & Recyclable

SOUND ABSORPTION

NRC Value 0.45 (ISO 11654)

FIRE RATING

A Class (ASTM E84) - B s1 d0 (EN 13501-1)

THERMAL INSULATION

0.035 W/mK



Product Code: BLD-20AA-BEG1091



Product Code: BLD-20AA-DGR2061



Product Code: BLD-20AA-GRY2011

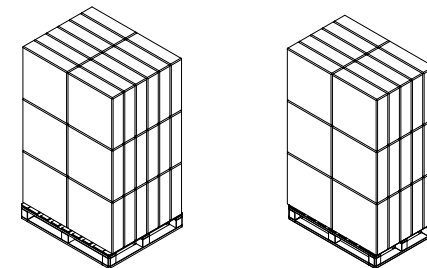

PALETTE SIZES & CONTENT

W: 1200mm D: 1000mm H: 2100mm W: 48" D: 40" H: 82"	W: 1200mm D: 800mm H: 2100mm W: 48" D: 31,5" H: 82"
1 Palette: 36 Pcs. Box	1 Palette: 30 Pcs. Box
Gross weight: 204Kg - 451 lbs	Gross weight: 170Kg - 375 lbs

Mix & Match

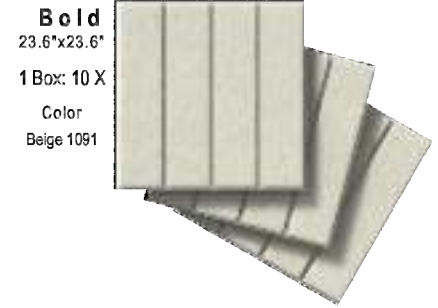
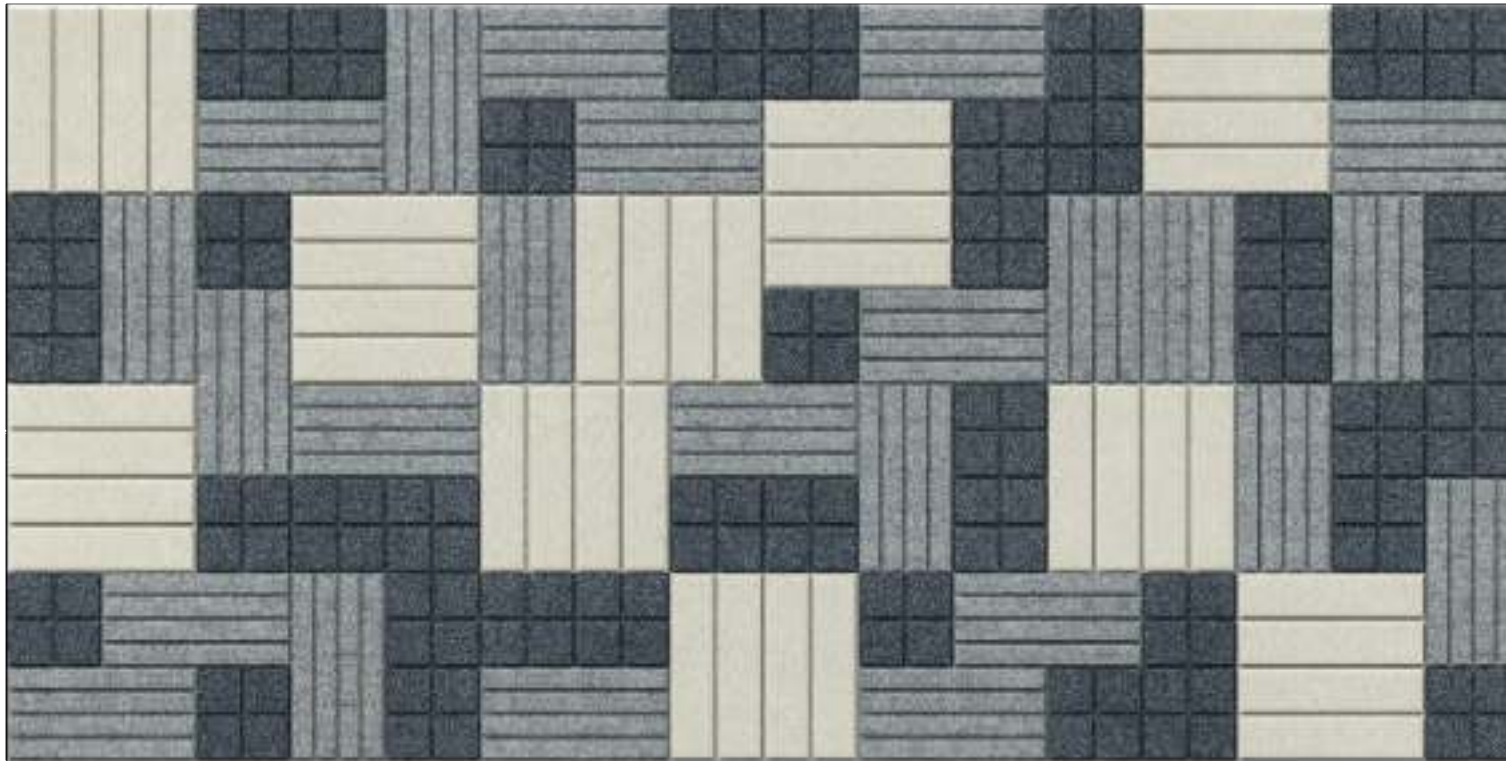

Bold, Ridge & Plaid combination; Dimensions: 15'-9.0" h: 7"-10.5" Area: 124 sq ft

Ridge





Plaid



Ridge



Bold



Plaid



Ridge

Plaid



Bold





Bold
Ridge
Plaid

Wall Panel
Moon

Beige 1091 Dark Grey 2061 Grey 2011

Saturn

Beige 1091 Dark Grey 2061 Grey 2011

Venus

Beige 1091 Dark Grey 2061 Grey 2011

Moon

APPLICATION

Internal Acoustic Control & Decorative Wall Panel
 Assembly Adhesive or Self Adhesived
 Double-Sided Tape Included For Installation

DIMENSIONS

W: 300mm (+/- 1mm) L: 300mm (+/- 1mm)
 W: 11.81" (+/-0.05") L: 11.81" (+/-0.05")

THICKNESS

Max. 13mm (+/- 2mm) - 0.51" (+/-0.08")
 Min. 3mm (+/- 2mm) - 0.12" (+/-0.08")



Smooth Surface - Impact Resistance - Flexible

WEIGHT

1 tile: 112.5gr. +/- 10% tolerance
 1 tile: 0.25 lbs with +/- 10% tolerance

BOX SIZE & CONTENT

W: 620mm D: 620mm H: 160mm
 W: 24,41" D: 24,41" H: 6,3"
 1 Box: 40 x Tiles
 1 Box: 3.6m2 / 38.75sqft
 1 Color of choice per package
 Gross weight: 5.2Kg - 11.5 lbs

MATERIAL

Mechanical needled punch industrial felt. 100%
 PET up to 60% Recycled content & Recyclable

SOUND ABSORPTION

NRC Value 0.45 (ISO 11654)

FIRE RATING

A Class (ASTM E84) - B s1 d0 (EN 13501-1)

THERMAL INSULATION

0,035 W/mK



Product Code: MON-20AA-BEG1091



Product Code: MON-20AA-DGR2061

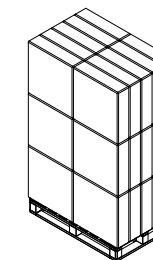
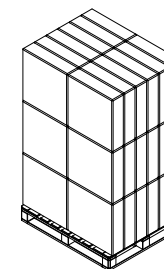

Product Code: MON-20AA-GRY2011

PALETTE SIZES & CONTENT

W: 1200mm D: 1000mm H: 2100mm W: 48" D: 40" H: 82"	W: 1200mm D: 800mm H: 2100mm W: 48" D: 31,5" H: 82"
1 Palette: 36 Pcs. Box	1 Palette: 30 Pcs. Box
Gross weight: 204Kg - 451 lbs	Gross weight: 170Kg - 375 lbs

Saturn

APPLICATION

Internal Acoustic Control & Decorative Wall Panel
 Assembly Adhesive or Self Adhesived
 Double-Sided Tape Included For Installation

DIMENSIONS

W: 600mm (+/- 1mm) L: 600mm (+/- 1mm)
 W: 23.62" (+/-0.05") L: 23.62" (+/-0.05")

THICKNESS



Max. 13mm (+/- 2mm) - 0.51" (+/-0.08")
 Min. 3mm (+/- 2mm) - 0.12" (+/-0.08")



Smooth Surface - Impact Resistance - Flexible

WEIGHT

1 tile: 450gr. +/- 10% tolerance
 1 tile: 1.00 lbs with +/- 10% tolerance

BOX SIZE & CONTENT

W: 620mm D: 620mm H: 160mm
 W: 24,41" D: 24,41" H: 6,3"
 1 Box: 10 x Tiles
 1 Box: 3.6m² / 38.75sqft
 1 Color of choice per package
 Gross weight: 5.2Kg - 11.5 lbs

MATERIAL

Mechanical needled punch industrial felt. 100%
 PET up to 60% Recycled content & Recyclable

SOUND ABSORPTION

NRC Value 0.45 (ISO 11654)

FIRE RATING

A Class (ASTM E84) - B s1 d0 (EN 13501-1)

THERMAL INSULATION

0.035 W/mK



Product Code: STN-20AA-BEG1091



Product Code: STN-20AA-DGR2061

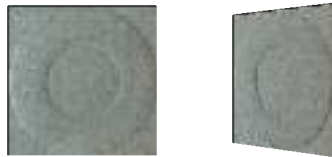

Product Code: STN-20AA-GRY2011

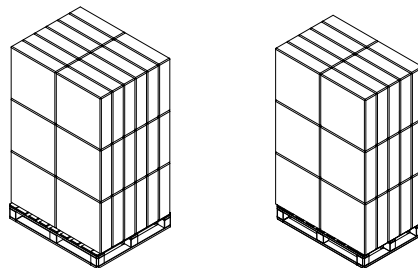

PALETTE SIZES & CONTENT

W: 1200mm D: 1000mm H: 2100mm W: 48" D: 40" H: 82"	W: 1200mm D: 800mm H: 2100mm W: 48" D: 31,5" H: 82"
1 Palette: 36 Pcs. Box	1 Palette: 30 Pcs. Box
Gross weight: 204Kg - 451 lbs	Gross weight: 170Kg - 375 lbs

Venus

APPLICATION

Internal Acoustic Control & Decorative Wall Panel
 Assembly Adhesive or Self Adhesived
 Double-Sided Tape Included For Installation

DIMENSIONS

W: 600mm (+/- 1mm) L: 600mm (+/- 1mm)
 W: 23.62" (+/-0.05") L: 23.62" (+/-0.05")

THICKNESS



Max. 13mm (+/- 2mm) - 0.51" (+/-0.08")
 Min. 3mm (+/- 2mm) - 0.12" (+/-0.08")



Smooth Surface - Impact Resistance - Flexible

WEIGHT

1 tile: 450gr. +/- 10% tolerance
 1 tile: 1.00 lbs with +/- 10% tolerance

BOX SIZE & CONTENT

W: 620mm D: 620mm H: 160mm
 W: 24,41" D: 24,41" H: 6,3"
 1 Box: 10 x Tiles
 1 Box: 3.6m² / 38.75sqft
 1 Color of choice per package
 Gross weight: 5.2Kg - 11.5 lbs

MATERIAL

Mechanical needled punch industrial felt. 100%
 PET up to 60% Recycled content & Recyclable

SOUND ABSORPTION

NRC Value 0.45 (ISO 11654)

FIRE RATING

A Class (ASTM E84) - B s1 d0 (EN 13501-1)

THERMAL INSULATION

0.035 W/mK



Product Code: VNS-20AA-BEG1091



Product Code: VNS-20AA-DGR2061

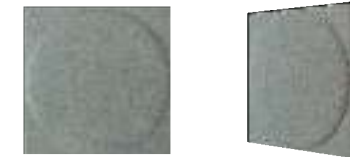

Product Code: VNS-20AA-GRY2011

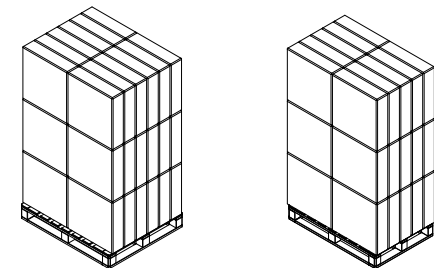

PALETTE SIZES & CONTENT

W: 1200mm D: 1000mm H: 2100mm W: 48" D: 40" H: 82"	W: 1200mm D: 800mm H: 2100mm W: 48" D: 31,5" H: 82"
1 Palette: 36 Pcs. Box	1 Palette: 30 Pcs. Box
Gross weight: 204Kg - 451 lbs	Gross weight: 170Kg - 375 lbs

Mix & Match



Saturn
23.6"x23.6"
1 Box: 10 X
Color
Dark Gray 2061



Venus
23.6"x23.6"
1 Box: 10 X
Color
Gray 2011



Moon
11.8"x11.8"
1 Box: 40 X
Color
Beige 1091



Saturn, Venus & Moon combination; Dimensions:14'-9.2" h:7"-10.5" Area: 116.3 sq ft



Moon

Saturn

Venus

Saturn Venus



Wall Panel

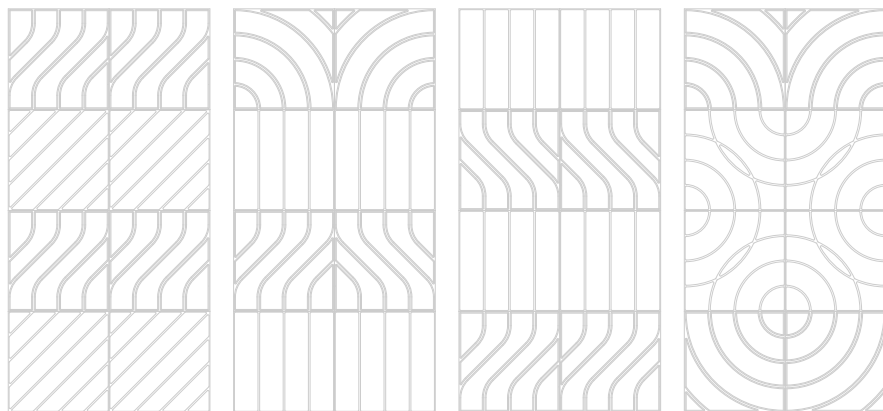

Zig



Beige 1091 Dark Grey 2061 Grey 2011

Zags



Beige 1091 Dark Grey 2061 Grey 2011

Corner



Beige 1091 Dark Grey 2061 Grey 2011

Central



Beige 1091 Dark Grey 2061 Grey 2011

Cross



Beige 1091 Dark Grey 2061 Grey 2011

Zig

APPLICATION

Internal Acoustic Control & Decorative Wall Panel
 Assembly Adhesive or Self Adhesived
 Double-Sided Tape Included For Installation

DIMENSIONS

W: 600mm (+/- 1mm) L: 600mm (+/- 1mm)
 W: 23.62" (+/-0.05") L: 23.62" (+/-0.05")

THICKNESS



Max. 13mm (+/- 2mm) - 0.51" (+/-0.08")
 Min. 3mm (+/- 2mm) - 0.12" (+/-0.08")



Smooth Surface - Impact Resistance - Flexible

WEIGHT

1 tile: 450gr. +/- 10% tolerance
 1 tile: 1.00 lbs with +/- 10% tolerance

BOX SIZE & CONTENT

W: 620mm D: 620mm H: 160mm
 W: 24,41" D: 24,41" H: 6,3"
 1 Box: 10 x Tiles
 1 Box: 3.6m² / 38.75sqft
 1 Color of choice per package
 Gross weight: 5.2Kg - 11.5 lbs

MATERIAL

Mechanical needled punch industrial felt. 100%
 PET up to 60% Recycled content & Recyclable

SOUND ABSORPTION

NRC Value 0.45 (ISO 11654)

FIRE RATING

A Class (ASTM E84) - B s1 d0 (EN 13501-1)

THERMAL INSULATION

0.035 W/mK



Product Code: ZIG-20AA-BEG1091



Product Code: ZIG-20AA-DGR2061



Product Code: ZIG-20AA-GRY2011

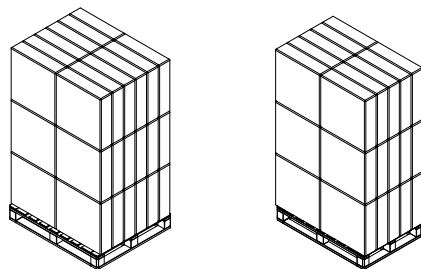

PALETTE SIZES & CONTENT

W: 1200mm D: 1000mm H: 2100mm W: 48" D: 40" H: 82"	W: 1200mm D: 800mm H: 2100mm W: 48" D: 31,5" H: 82"
1 Palette: 36 Pcs. Box	1 Palette: 30 Pcs. Box
Gross weight: 204Kg - 451 lbs	Gross weight: 170Kg - 375 lbs

Zag

APPLICATION

Internal Acoustic Control & Decorative Wall Panel
 Assembly Adhesive or Self Adhesived
 Double-Sided Tape Included For Installation

DIMENSIONS

W: 600mm (+/- 1mm) L: 600mm (+/- 1mm)
 W: 23.62" (+/-0.05") L: 23.62" (+/-0.05")

THICKNESS



Max. 13mm (+/- 2mm) - 0.51" (+/-0.08")
 Min. 3mm (+/- 2mm) - 0.12" (+/-0.08")



Smooth Surface - Impact Resistance - Flexible

WEIGHT

1 tile: 450gr. +/- 10% tolerance
 1 tile: 1.00 lbs with +/- 10% tolerance

BOX SIZE & CONTENT

W: 620mm D: 620mm H: 160mm
 W: 24,41" D: 24,41" H: 6,3"
 1 Box: 10 x Tiles
 1 Box: 3.6m² / 38.75sqft
 1 Color of choice per package
 Gross weight: 5.2Kg - 11.5 lbs

MATERIAL

Mechanical needled punch industrial felt. 100%
 PET up to 60% Recycled content & Recyclable

SOUND ABSORPTION

NRC Value 0.45 (ISO 11654)

FIRE RATING

A Class (ASTM E84) - B s1 d0 (EN 13501-1)

THERMAL INSULATION

0.035 W/mK



Product Code: ZAG-20AA-BEG1091



Product Code: ZAG-20AA-DGR2061



Product Code: ZAG-20AA-GRY2011

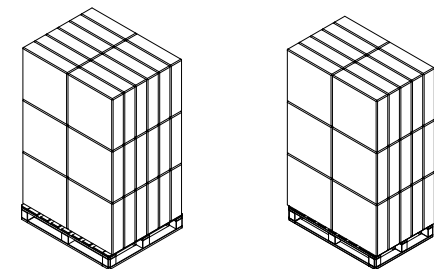

PALETTE SIZES & CONTENT

W: 1200mm D: 1000mm H: 2100mm W: 48" D: 40" H: 82"	W: 1200mm D: 800mm H: 2100mm W: 48" D: 31,5" H: 82"
1 Palette: 36 Pcs. Box	1 Palette: 30 Pcs. Box
Gross weight: 204Kg - 451 lbs	Gross weight: 170Kg - 375 lbs

Corner

APPLICATION

Internal Acoustic Control & Decorative Wall Panel
 Assembly Adhesive or Self Adhesived
 Double-Sided Tape Included For Installation

DIMENSIONS

W: 600mm (+/- 1mm) L: 600mm (+/- 1mm)
 W: 23.62" (+/-0.05") L: 23.62" (+/-0.05")

THICKNESS



Max. 13mm (+/- 2mm) - 0.51" (+/-0.08")
 Min. 3mm (+/- 2mm) - 0.12" (+/-0.08")



Smooth Surface - Impact Resistance - Flexible

WEIGHT

1 tile: 450gr. +/- 10% tolerance
 1 tile: 1.00 lbs with +/- 10% tolerance

BOX SIZE & CONTENT

W: 620mm D: 620mm H: 160mm
 W: 24,41" D: 24,41" H: 6,3"
 1 Box: 10 x Tiles
 1 Box: 3.6m² / 38.75sqft
 1 Color of choice per package
 Gross weight: 5.2Kg - 11.5 lbs

MATERIAL

Mechanical needled punch industrial felt. 100%
 PET up to 60% Recycled content & Recyclable

SOUND ABSORPTION

NRC Value 0.45 (ISO 11654)

FIRE RATING

A Class (ASTM E84) - B s1 d0 (EN 13501-1)

THERMAL INSULATION

0.035 W/mK



Product Code: CRN-20AA-BEG1091



Product Code: CRN-20AA-DGR2061



Product Code: CRN-20AA-GRY2011

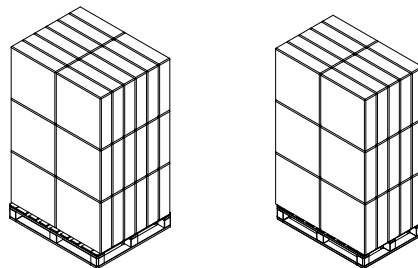

PALETTE SIZES & CONTENT

W: 1200mm D: 1000mm H: 2100mm W: 48" D: 40" H: 82"	W: 1200mm D: 800mm H: 2100mm W: 48" D: 31,5" H: 82"
1 Palette: 36 Pcs. Box	1 Palette: 30 Pcs. Box
Gross weight: 204Kg - 451 lbs	Gross weight: 170Kg - 375 lbs

Central

APPLICATION

Internal Acoustic Control & Decorative Wall Panel
 Assembly Adhesive or Self Adhesived
 Double-Sided Tape Included For Installation

DIMENSIONS

W: 600mm (+/- 1mm) L: 600mm (+/- 1mm)
 W: 23.62" (+/-0.05") L: 23.62" (+/-0.05")

THICKNESS



Max. 13mm (+/- 2mm) - 0.51" (+/-0.08")
 Min. 3mm (+/- 2mm) - 0.12" (+/-0.08")



Smooth Surface - Impact Resistance - Flexible

WEIGHT

1 tile: 450gr. +/- 10% tolerance
 1 tile: 1.00 lbs with +/- 10% tolerance

BOX SIZE & CONTENT

W: 620mm D: 620mm H: 160mm
 W: 24,41" D: 24,41" H: 6,3"
 1 Box: 10 x Tiles
 1 Box: 3.6m² / 38.75sqft
 1 Color of choice per package
 Gross weight: 5.2Kg - 11.5 lbs

MATERIAL

Mechanical needled punch industrial felt. 100%
 PET up to 60% Recycled content & Recyclable

SOUND ABSORPTION

NRC Value 0.45 (ISO 11654)

FIRE RATING

A Class (ASTM E84) - B s1 d0 (EN 13501-1)

THERMAL INSULATION

0.035 W/mK



Product Code: CNL-20AA-BEG1091



Product Code: CNL-20AA-DGR2061



Product Code: CNL-20AA-GRY2011

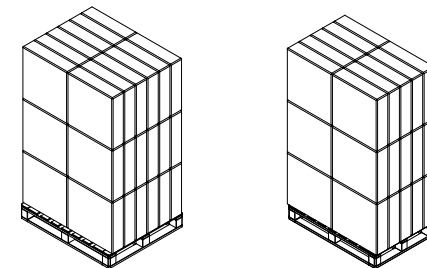

PALETTE SIZES & CONTENT

W: 1200mm D: 1000mm H: 2100mm W: 48" D: 40" H: 82"	W: 1200mm D: 800mm H: 2100mm W: 48" D: 31,5" H: 82"
1 Palette: 36 Pcs. Box	1 Palette: 30 Pcs. Box
Gross weight: 204Kg - 451 lbs	Gross weight: 170Kg - 375 lbs

Cross

APPLICATION

Internal Acoustic Control & Decorative Wall Panel
 Assembly Adhesive or Self Adhesived
 Double-Sided Tape Included For Installation

DIMENSIONS

W: 600mm (+/- 1mm) L: 600mm (+/- 1mm)
 W: 23.62" (+/-0.05") L: 23.62" (+/-0.05")

THICKNESS



Max. 13mm (+/- 2mm) - 0.51" (+/-0.08")
 Min. 3mm (+/- 2mm) - 0.12" (+/-0.08")



Smooth Surface - Impact Resistance - Flexible

WEIGHT

1 tile: 450gr. +/- 10% tolerance
 1 tile: 1.00 lbs with +/- 10% tolerance

BOX SIZE & CONTENT

W: 620mm D: 620mm H: 160mm
 W: 24,41" D: 24,41" H: 6,3"
 1 Box: 10 x Tiles
 1 Box: 3.6m² / 38.75sqft
 1 Color of choice per package
 Gross weight: 5.2Kg - 11.5 lbs

MATERIAL

Mechanical needled punch industrial felt. 100%
 PET up to 60% Recycled content & Recyclable

SOUND ABSORPTION

NRC Value 0.45 (ISO 11654)

FIRE RATING

A Class (ASTM E84) - B s1 d0 (EN 13501-1)

THERMAL INSULATION

0.035 W/mK



Product Code: CRS-20AA-BEG1091



Product Code: CRS-20AA-DGR2061

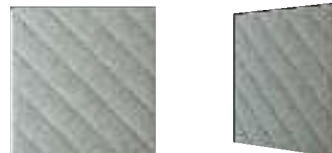

Product Code: CRS-20AA-GRY2011

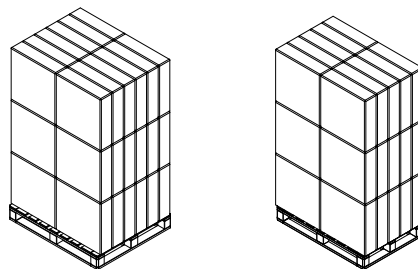

PALETTE SIZES & CONTENT

W: 1200mm D: 1000mm H: 2100mm W: 48" D: 40" H: 82"	W: 1200mm D: 800mm H: 2100mm W: 48" D: 31,5" H: 82"
1 Palette: 36 Pcs. Box	1 Palette: 30 Pcs. Box
Gross weight: 204Kg - 451 lbs	Gross weight: 170Kg - 375 lbs

Bold

APPLICATION

Internal Acoustic Control & Decorative Wall Panel
 Assembly Adhesive or Self Adhesived
 Double-Sided Tape Included For Installation

DIMENSIONS

W: 600mm (+/- 1mm) L: 600mm (+/- 1mm)
 W: 23.62" (+/-0.05") L: 23.62" (+/-0.05")

THICKNESS



Max. 13mm (+/- 2mm) - 0.51" (+/-0.08")
 Min. 3mm (+/- 2mm) - 0.12" (+/-0.08")



Smooth Surface - Impact Resistance - Flexible

WEIGHT

1 tile: 450gr. +/- 10% tolerance
 1 tile: 1.00 lbs with +/- 10% tolerance

BOX SIZE & CONTENT

W: 620mm D: 620mm H: 160mm
 W: 24,41" D: 24,41" H: 6,3"
 1 Box: 10 x Tiles
 1 Box: 3.6m² / 38.75sqft
 1 Color of choice per package
 Gross weight: 5.2Kg - 11.5 lbs

MATERIAL

Mechanical needled punch industrial felt. 100%
 PET up to 60% Recycled content & Recyclable

SOUND ABSORPTION

NRC Value 0.45 (ISO 11654)

FIRE RATING

A Class (ASTM E84) - B s1 d0 (EN 13501-1)

THERMAL INSULATION

0.035 W/mK



Product Code: BLD-20AA-BEG1091



Product Code: BLD-20AA-DGR2061



Product Code: BLD-20AA-GRY2011

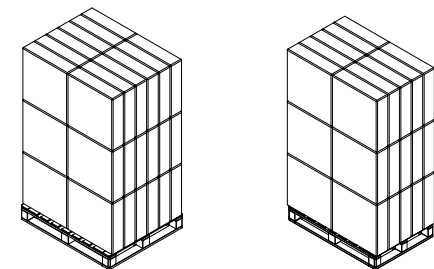

PALETTE SIZES & CONTENT

W: 1200mm D: 1000mm H: 2100mm W: 48" D: 40" H: 82"	W: 1200mm D: 800mm H: 2100mm W: 48" D: 31,5" H: 82"
1 Palette: 36 Pcs. Box	1 Palette: 30 Pcs. Box
Gross weight: 204Kg - 451 lbs	Gross weight: 170Kg - 375 lbs

Mix & Match

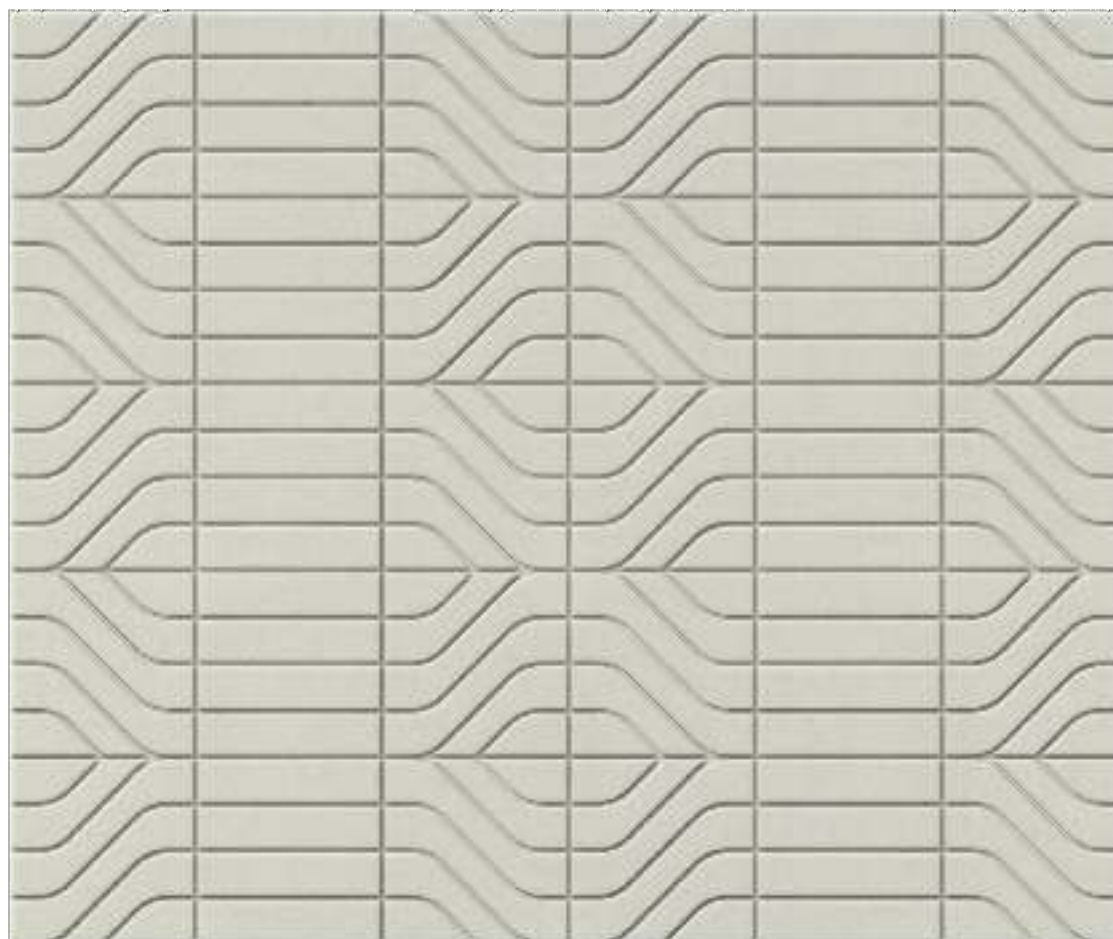

Zig
23.6"x23.6"
1 Box: 10 X
Color
Beige 1091



Zag
23.6"x23.6"
1 Box: 10 X
Color
Beige 1091



Bold
23.6"x23.6"
1 Box: 10 X
Color
Beige 1091



Zig, Zag & Bold combination; Dimensions:13'-9.4" h:9"-10.1" Area: 116.3 sq ft

Mix & Match



Bold
23.6"x23.6"
1 Box: 10 X
Color
Dark Gray 2061



Zag
23.6"x23.6"
1 Box: 10 X
Color
Dark Gray 2061



Bold & Zag combination; Dimensions:9'-10.1" h:7"-10.5" Area: 77.5 sq ft

Mix & Match

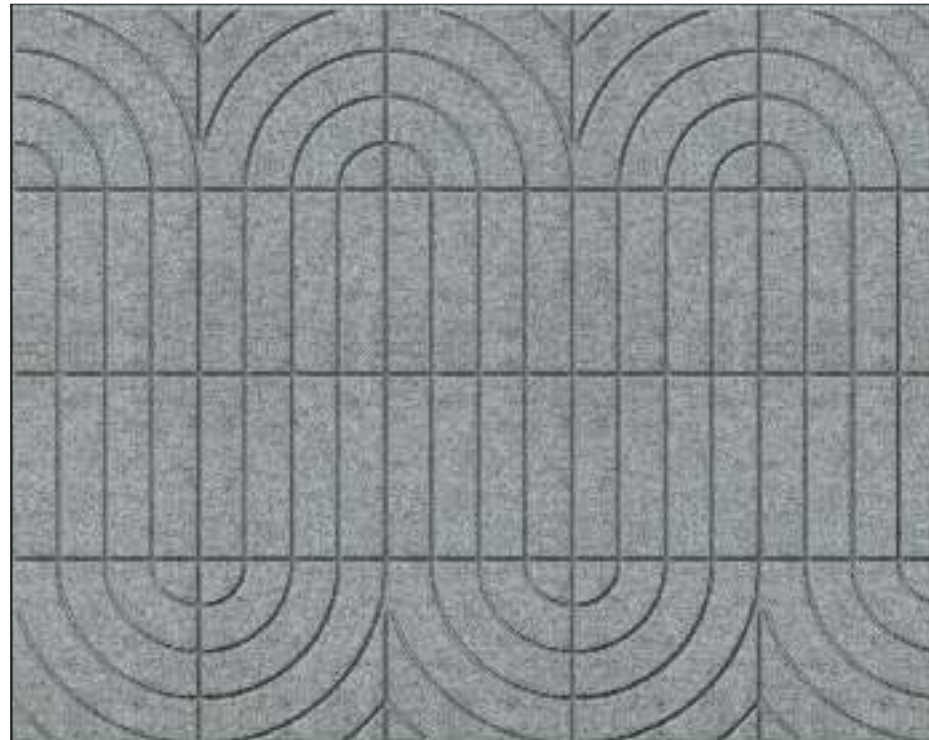

Corner
23.6"x23.6"
1 Box: 10 X
Color
Gray 2011

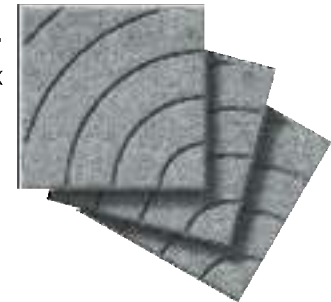

Bold
23.6"x23.6"
1 Box: 10 X
Color
Gray 2011



Corner & Bold combination; Dimensions:9'-10.1" h:7"-10.5" Area: 77.5 sq ft

Mix & Match

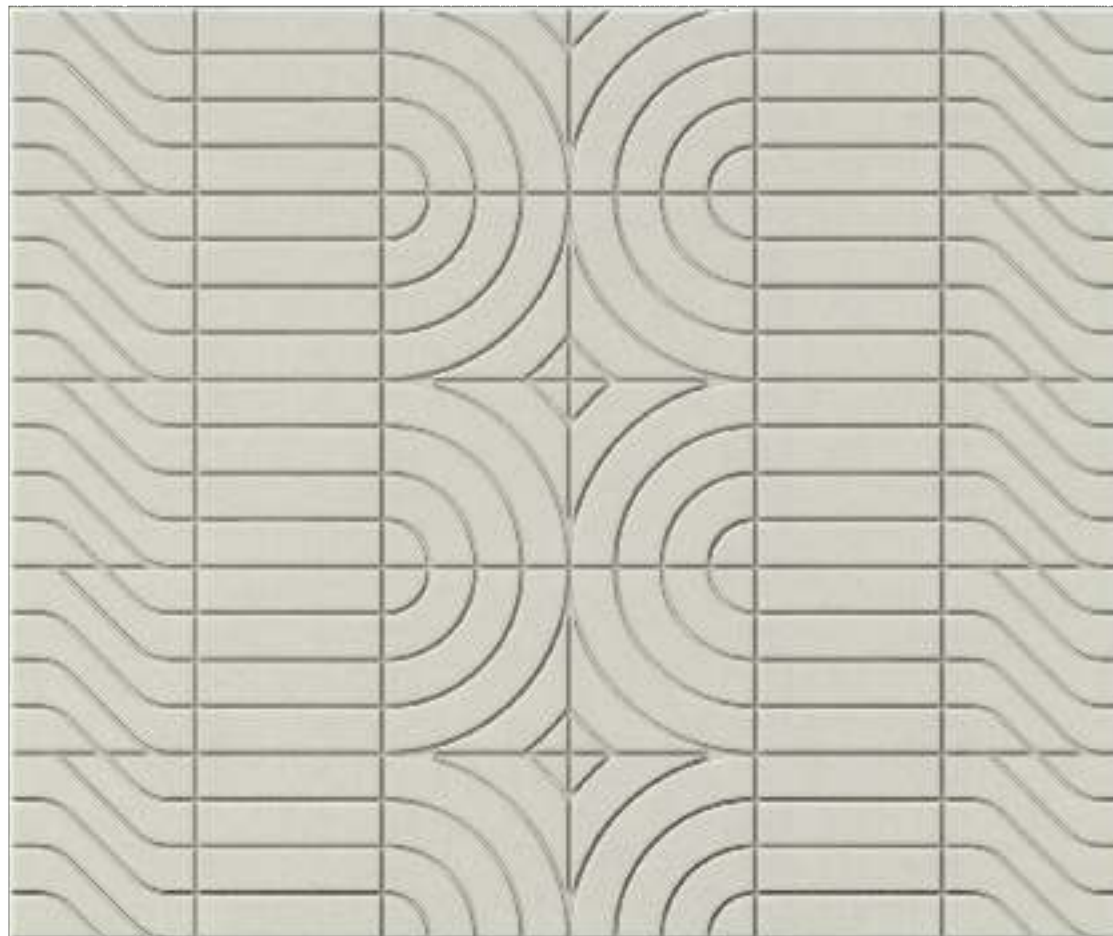

Corner
23.6"x23.6"
1 Box: 10 X
Color
Beige 1091



Zag
23.6"x23.6"
1 Box: 10 X
Color
Beige 1091



Bold
23.6"x23.6"
1 Box: 10 X
Color
Beige 1091



Corner, Zag & Bold combination; Dimensions:13'-9.4" h:9"-10.1" Area: 116.3 sq ft

Mix & Match



Cross
23.6"x23.6"
1 Box: 10 X
Color
Dark Gray 2061



Cross combination; Dimensions:9'-10.1" h:7"-10.5" Area: 77.5 sq ft

Wall Panel

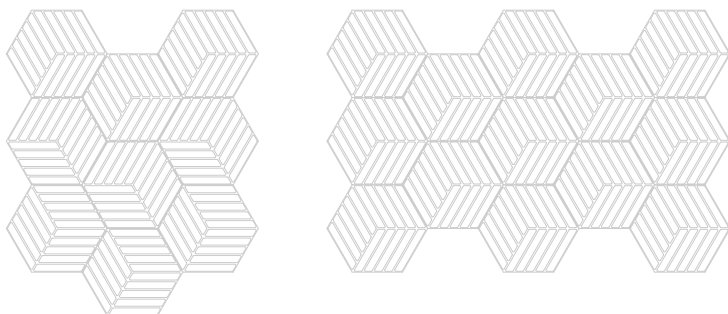
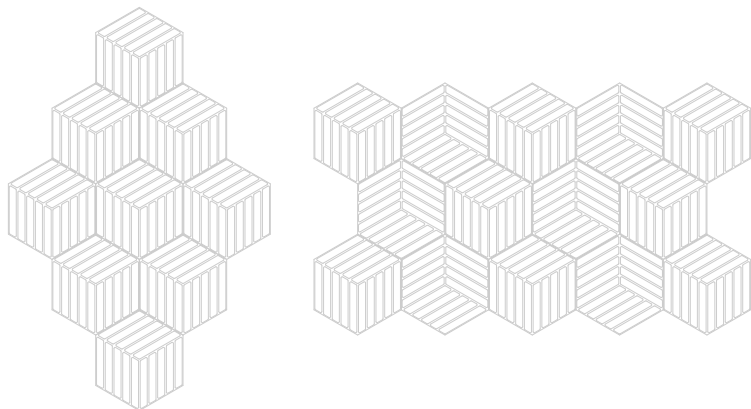
Hex-One

Beige 1091

Dark Grey 2061

Grey 2011

Hex-One

APPLICATION

Internal Acoustic Control & Decorative Wall Panel
 Assembly Adhesive or Self Adhesived
 Double-Sided Tape Included For Installation

DIMENSIONS

W: 600mm (+/- 1mm) L: 520mm (+/- 1mm)
 Hex. Edge: 300mm
 W: 23,62" (+/-0.05") L: 23,62" (+/-0.05")
 Hex. Edge: 11,81"

THICKNESS

Max. 13mm (+/- 2mm) - 0.51" (+/-0.08")
 Min. 3mm (+/- 2mm) - 0.12" (+/-0.08")



Smooth Surface - Impact Resistance - Flexible

WEIGHT

1 tile: 292.5gr. +/- 10% tolerance
 1 tile: 0.64 lbs with +/- 10% tolerance

BOX SIZE & CONTENT

W: 620mm D: 620mm H: 160mm
 W: 24,41" D: 24,41" H: 6,3"
 1 Box: 10 x Tiles
 1 Box: 3.12m² / 33.58sqft
 1 Color of choice per package
 Gross weight: 3.7Kg - 8.10 lbs

MATERIAL

Mechanical needled punch industrial felt. 100%
 PET up to 60% Recycled content & Recyclable

SOUND ABSORPTION

NRC Value 0.45 (ISO 11654)

FIRE RATING

A Class (ASTM E84) - B s1 d0 (EN 13501-1)

THERMAL INSULATION

0.035 W/mK



Product Code: HXO-20AA-BEG1091

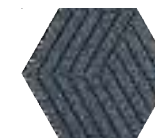

Product Code: HXO-20AA-DGR2061

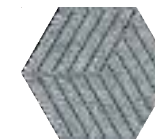

Product Code: HXO-20AA-GRY2011

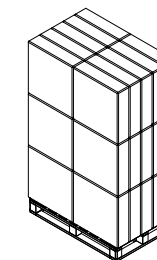
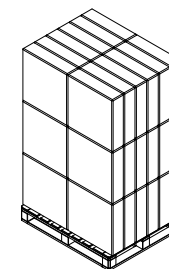
PALETTE SIZES & CONTENT

W: 1200mm D: 1000mm H: 2100mm W: 48" D: 40" H: 82"	W: 1200mm D: 800mm H: 2100mm W: 48" D: 31,5" H: 82"
1 Palette: 36 Pcs. Box	1 Palette: 30 Pcs. Box
Gross weight: 148Kg - 326 lbs	Gross weight: 123Kg - 270 lbs

Mix & Match

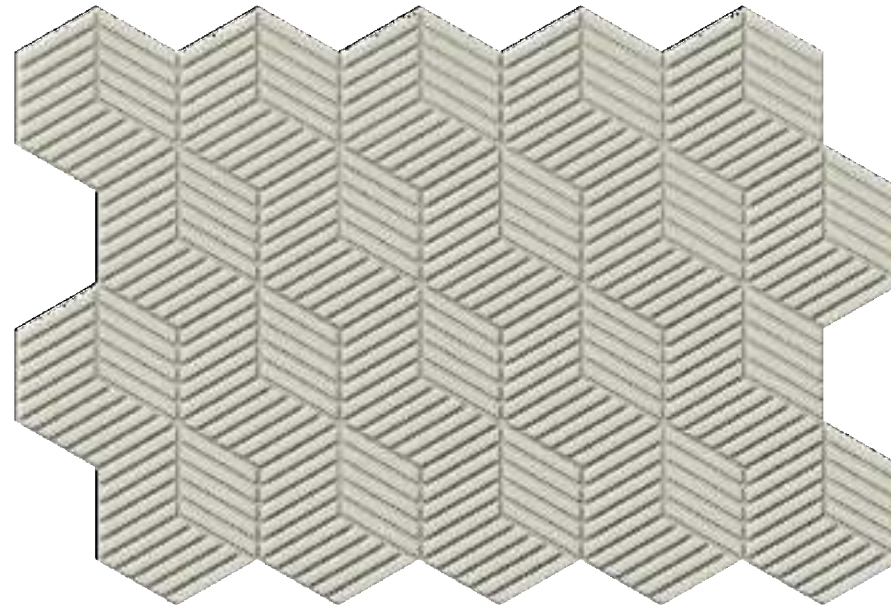

Hex-One
23.6"x20.5"
1 Box: 10 X
Color
Beige 1091



Hex-One combination; Dimensions: 9'-4.5" h: 6"-4.8" Area: 50.3 sq ft

Wall Panel

The "Woodie" acoustic panel is high quality printed, oak & walnut visualisation can be chosen. To customize your order according to your preferences, you can select combinations based on box quantities and colors.

Woodie Small

Oak 9002



Walnut 9001

Woodie Small

150mm x 1200mm
APPLICATION

Internal Acoustic Control & Decorative Wall Panel
 Assembly Adhesive or Self Adhesived
 Double-Sided Tape Included For Installation

DIMENSIONS

W: 150mm (+/- 1mm) L: 1200mm (+/- 1mm)
 W: 5.91" (+/-0.05") L: 47.24" (+/-0.05")

THICKNESS

Max. 13mm (+/- 2mm) - 0.51" (+/-0.08")
 Min. 3mm (+/- 2mm) - 0.12" (+/-0.08")



Smooth Surface - Impact Resistance - Flexible

WEIGHT

1 tile: 405gr. +/- 10% tolerance
 1 tile: 0.9 lbs with +/- 10% tolerance

BOX SIZE & CONTENT

W: 620mm D: 1220mm H: 100mm
 W: 24,41" D: 48,03" H: 3,94"
 1 Box: 24 x Tiles
 1 Box: 4.32m2 / 46.5sqft
 1 Color of choice per package
 Gross weight: 10.65Kg - 23.45 lbs

MATERIAL

Mechanical needled punch industrial felt. 100% PET up to 60% Recycled content & Recyclable

SOUND ABSORPTION

NRC Value 0.65 (ISO 11654)

FIRE RATING

A Class (ASTM E84) - B s1 d0 (EN 13501-1)

THERMAL INSULATION

0.035 W/mK



Product Code: WFS-20AA-OD9002

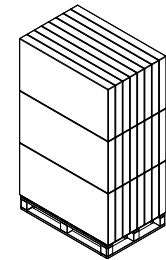
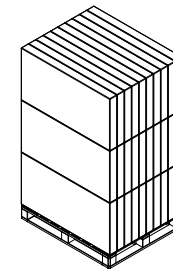

Product Code: WFS-20AA-WD9001

PALETTE SIZES & CONTENT

W: 1200mm D: 1000mm H: 2100mm W: 48" D: 40" H: 82"	W: 1200mm D: 800mm H: 2100mm W: 48" D: 31,5" H: 82"
1 Palette: 36 Pcs. Box	1 Palette: 30 Pcs. Box
Gross weight: 398Kg - 878 lbs	Gross weight: 332Kg - 731 lbs

Striped Large

Beige 1091

Dark Grey 2061

Grey 2011

Striped Large

APPLICATION

Internal Acoustic Control & Decorative Wall Panel
 Assembly Adhesive or Self Adhesived
 Double-Sided Tape Included For Installation

DIMENSIONS

W: 600mm (+/- 1mm) L: 2400mm (+/- 1mm)
 W: 23.62" (+/-0.05") L: 94.49" (+/-0.05")

THICKNESS



Max. 13mm (+/- 2mm) - 0.51" (+/-0.08")
 Min. 3mm (+/- 2mm) - 0.12" (+/-0.08")



Smooth Surface - Impact Resistance - Flexible

WEIGHT

1 tile: 2910gr. +/- 10% tolerance
 1 tile: 6.42 lbs with +/- 10% tolerance

BOX SIZE & CONTENT

W: 2420mm D: 620mm H: 100mm
 W: 95,28" D: 24,41" H: 3,94"
 1 Box : 6 x Tiles
 1 Box : 8,64m² / 93sqft
 1 Color of choice per package
 Gross weight : 19.3Kg - 42.5 lbs

MATERIAL

Mechanical needled punch industrial felt. 100%
 PET up to 60% Recycled content & Recyclable

SOUND ABSORPTION

NRC Value 0.80 (ISO 11654)

FIRE RATING

A Class (ASTM E84) - B s1 d0 (EN 13501-1)

THERMAL INSULATION

0.035 W/mK



Product Code: STL-20AA-BEG1091



Product Code: STL-20AA-DGR2061



Product Code: STL-20AA-GRY2011

PALETTE SIZE & CONTENT

W: 2420mm W: 96"
 D: 800mm D: 31,5"
 H: 2100mm H: 82"

1 Palette: 24 Pcs. Box

Gross weight: 478Kg
 1054 lbs

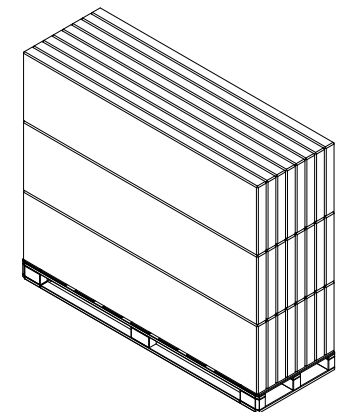

Striped Large





Ceiling Tile

The "Cross Drop-In" acoustic ceiling panel dimensions are compatible with T24 Lay-In systems.

Cross Drop-In

APPLICATION

Internal Acoustic Control & Decorative Ceiling Tile
 Compatible with T24 Lay-In ceilings
 Only ceiling panel is supplied.

DIMENSIONS

W: 595mm (+/- 1mm) L: 595mm (+/- 1mm)
 W: 23.43" (+/-0.05") L: 23.43" (+/-0.05")

THICKNESS



Max. 13mm (+/- 2mm) - 0.51" (+/-0.08")
 Min. 3mm (+/- 2mm) - 0.12" (+/-0.08")



Smooth Surface - Impact Resistance - Flexible

WEIGHT

1 tile: 690gr. +/- 10% tolerance
 1 tile: 1.52 lbs with +/- 10% tolerance

BOX SIZE & CONTENT

W: 620mm D: 620mm H: 160mm
 W: 24,41" D: 24,41" H: 6,3"
 1 Box: 10 x Tiles
 1 Box: 3.54m² / 38.11sqft
 1 Color of choice per package
 Gross weight: 7.65Kg - 16.85 lbs

MATERIAL

Mechanical needled punch industrial felt. 100% PET up to 60% Recycled content & Recyclable

SOUND ABSORPTION

NRC Value 0.85 (ISO 11654)

FIRE RATING

A Class (ASTM E84) - B s1 d0 (EN 13501-1)

THERMAL INSULATION

0.035 W/mK



Product Code: CRD-30DI-BEG1091



Product Code: CRD-30DI-DGR2061



Product Code: CRD-30DI-GRY2011

Cross Drop-In



Beige 1091

Dark Grey 2061

Grey 2011

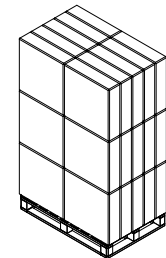
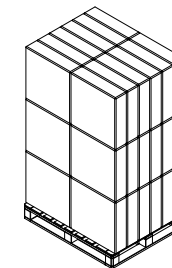

PALETTE SIZES & CONTENT

W: 1200mm D: 1000mm H: 2100mm W: 48" D: 40" H: 82"	W: 1200mm D: 800mm H: 2100mm W: 48" D: 31,5" H: 82"
1 Palette: 36 Pcs. Box	1 Palette: 30 Pcs. Box
Gross weight: 291Kg - 641 lbs	Gross weight: 242Kg - 533 lbs

Ceiling Pendant

The "Rotund Small, Medium and Large" acoustic ceiling pendants



Beige 1091

Dark Grey 2061

Grey 2011

Rotund Small R 600

APPLICATION

Internal Acoustic Control & Decorative Ceiling Pendant
Suspended With Adjustable Hanging Sets
3 pcs. Set Is Supplied For Each Unit

DIMENSIONS

R: 600mm (+/- 1mm)
R: 23.62" (+/-0.05")

THICKNESS

Max. 35mm (+/- 2mm) - 1.38" (+/-0.08")
Edge 8mm (+/- 2mm) - 0.31" (+/-0.08")

Smooth Surface - Impact Resistance - Flexible

WEIGHT

1 tile: 870gr. +/- 10% tolerance
1 tile: 1.92 lbs with +/- 10% tolerance
(without hanging sets)

BOX SIZE & CONTENT

W: 620mm D: 620mm H: 160mm
W: 24,41" D: 24,41" H: 6,3"
1 Box: 4 x Pendants
1 Box: 1.13m² / 12.17sqft
1 Color of choice per package
Gross weight: 4Kg - 8.9 lbs

MATERIAL

Mechanical needled punch industrial felt. 100%
PET up to 60% Recycled content & Recyclable

SOUND ABSORPTION

NRC Value 0.90 (ISO 11654)

FIRE RATING

A Class (ASTM E84) - B s1 d0 (EN 13501-1)

THERMAL INSULATION

0.035 W/mK



Product Code: RTS-10HG-BEG1091



Product Code: RTS-10HG-DGR2061

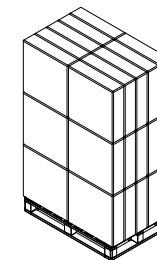
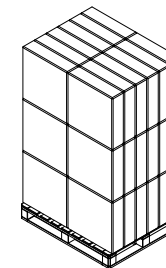

Product Code: RTS-10HG-GRY2011

PALETTE SIZES & CONTENT

W: 1200mm D: 1000mm H: 2100mm W: 48" D: 40" H: 82"	W: 1200mm D: 800mm H: 2100mm W: 48" D: 31,5" H: 82"
1 Palette: 36 Pcs. Box	1 Palette: 30 Pcs. Box
Gross weight: 150Kg - 331 lbs	Gross weight: 134Kg - 296 lbs

Rotund Medium R 900

APPLICATION

Internal Acoustic Control & Decorative Ceiling Pendant
Suspended With Adjustable Hanging Sets
4 pcs. Set Is Supplied For Each Unit

DIMENSIONS

R: 900mm (+/- 1mm)
R: 35.44" (+/-0.05")

THICKNESS



Max. 40mm (+/- 2mm) - 1.57" (+/-0.08")
Edge 8mm (+/- 2mm) - 0.31" (+/-0.08")

Smooth Surface - Impact Resistance - Flexible

WEIGHT

1 tile: 1950gr. +/- 10% tolerance
1 tile: 4.3 lbs with +/- 10% tolerance
(without hanging sets)

BOX SIZE & CONTENT

W: 920mm D: 920mm H: 100mm
W: 36.22" D: 36.22" H: 3.94"
1 Box: 2 pcs.
1 Box: 1.27m² / 13.70sqft
1 Color of choice per package
Gross weight: 3.9Kg - 8.6 lbs

MATERIAL

Mechanical needled punch industrial felt. 100%
PET up to 60% Recycled content & Recyclable

SOUND ABSORPTION

NRC Value 0.90 (ISO 11654)

FIRE RATING

A Class (ASTM E84) - B s1 d0 (EN 13501-1)

THERMAL INSULATION

0.035 W/mK



Product Code: RTM-20HG-BEG1091



Product Code: RTM-20HG-DGR2061



Product Code: RTM-20HG-GRY2011

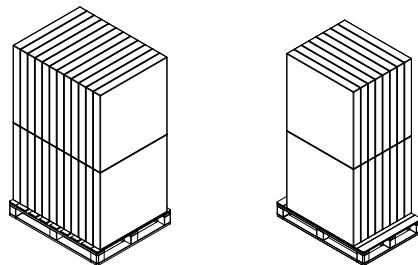

PALETTE SIZES & CONTENT

W: 1200mm D: 1000mm H: 2100mm W: 48" D: 40" H: 82"	W: 1200mm D: 800mm H: 2100mm W: 48" D: 31,5" H: 82"
1 Palette: 24 Pcs. Box	1 Palette: 16 Pcs. Box
Gross weight: 134Kg - 296 lbs	Gross weight: 91Kg - 202 lbs

Rotund Large R 1200

APPLICATION

Internal Acoustic Control & Decorative Ceiling Pendant
Suspended With Adjustable Hanging Sets
4 pcs. Set Is Supplied For Each Unit

DIMENSIONS

R: 1200mm (+/- 1mm)
R: 47.24" (+/-0.05")

THICKNESS



Max. 40mm (+/- 2mm) - 1.57" (+/-0.08")
Edge 8mm (+/- 2mm) - 0.31" (+/-0.08")

Smooth Surface - Impact Resistance - Flexible

WEIGHT

1 tile: 3500gr. +/- 10% tolerance
1 tile: 7.72 lbs with +/- 10% tolerance
(without hanging sets)

BOX SIZE & CONTENT

W: 1220mm D: 1220mm H: 100mm
W: 48.03" D: 48.03" H: 3.94"
1 Box: 2 pcs.
1 Box: 2.26m² / 24.35sqft
1 Color of choice per package
Gross weight: 9Kg - 19.5 lbs

MATERIAL

Mechanical needled punch industrial felt. 100%
PET up to 60% Recycled content & Recyclable

SOUND ABSORPTION

NRC Value 0.90 (ISO 11654)

FIRE RATING

A Class (ASTM E84) - B s1 d0 (EN 13501-1)

THERMAL INSULATION

0.035 W/mK

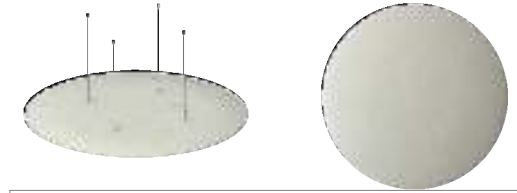

Product Code: RTL-30HG-BEG1091

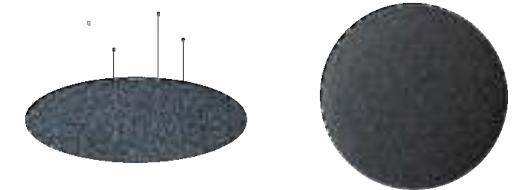

Product Code: RTL-30HG-DGR2061

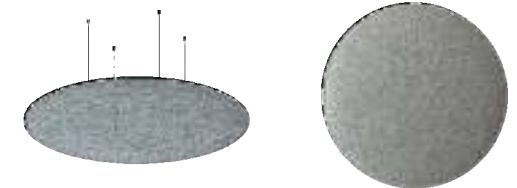

Product Code: RTL-30HG-GRY2011

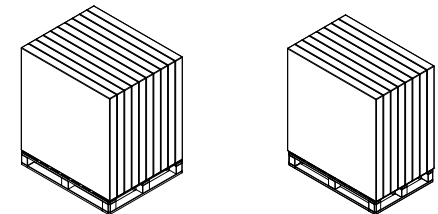

PALETTE SIZES & CONTENT

W: 1200mm D: 1000mm H: 1400mm W: 48" D: 40" H: 55"	W: 1200mm D: 800mm H: 1400mm W: 48" D: 31,5" H: 55"
1 Palette: 10 Pcs. Box	1 Palette: 8 Pcs. Box
Gross weight: 335Kg - 738 lbs	Gross weight: 279Kg - 614 lbs





Ceiling Pendant

The "Oblong Small", "Frame Large" and "Oblong Large" are acoustic ceiling pendants



Beige 1091

Dark Grey 2061

Grey 2011

Oblong Small

600mm x 1200mm

APPLICATION

Internal Acoustic Control & Decorative Ceiling Pendant
Suspended With Adjustable Hanging Sets
4 pcs. Set Is Supplied For Each Unit

DIMENSIONS

W: 600mm (+/- 1mm) L: 1200mm (+/- 1mm)
W: 23.62" (+/-0.05") L: 47.24" (+/-0.05")

THICKNESS



Max. 40mm (+/- 2mm) - 1.57" (+/-0.08")
Edge 8mm (+/- 2mm) - 0.31" (+/-0.08")

Smooth Surface - Impact Resistance - Flexible

WEIGHT

1 tile: 2150gr. +/- 10% tolerance
1 tile: 4.74 lbs with +/- 10% tolerance
(without hanging sets)

BOX SIZE & CONTENT

W: 620mm D: 1220mm H: 100mm
W: 24.41" D: 48.03" H: 3.94"
1 Box: 2 x Pendants
1 Box: 1.4m² / 15.5sqft
1 Color of choice per package
Gross weight: 6.0Kg - 13.2 lbs

MATERIAL

Mechanical needled punch industrial felt. 100%
PET up to 60% Recycled content & Recyclable

SOUND ABSORPTION

NRC Value 0.90 (ISO 11654)

FIRE RATING

A Class (ASTM E84) - B s1 d0 (EN 13501-1)

THERMAL INSULATION

0.035 W/mK



Product Code: OBS-10HG-BEG1091

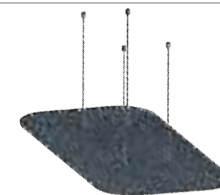

Product Code: OBS-10HG-DGR2061

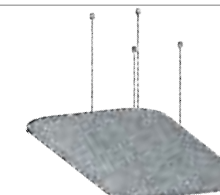

Product Code: OBS-10HG-GRY2011

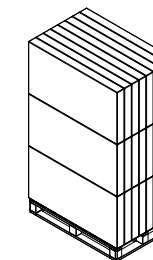
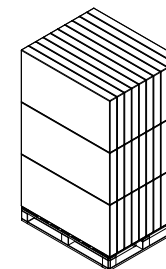

PALETTE SIZES & CONTENT

W: 1200mm D: 1000mm H: 2100mm W: 48" D: 40" H: 82"	W: 1200mm D: 800mm H: 2100mm W: 48" D: 31,5" H: 82"
1 Palette: 36 Pcs. Box	1 Palette: 30 Pcs. Box
Gross weight: 150Kg - 331 lbs	Gross weight: 120Kg - 265 lbs

Frame Large

1200mm x 1200mm

APPLICATION

Internal Acoustic Control & Decorative Ceiling Pendant
Suspended With Adjustable Hanging Sets
4 pcs. Set Is Supplied For Each Unit

DIMENSIONS

W: 1200mm (+/- 1mm) - L: 1200mm (+/- 1mm)
W: 47.24" (+/-0.05") - L: 47.24" (+/-0.05")

THICKNESS



Max. 40mm (+/- 2mm) - 1.57" (+/-0.08")
Edge 8mm (+/- 2mm) - 0.31" (+/-0.08")

Smooth Surface - Impact Resistance - Flexible

WEIGHT

1 tile: 4350gr. +/- 10% tolerance
1 tile: 9.61 lbs with +/- 10% tolerance
(without hanging sets)

BOX SIZE & CONTENT

W: 1220mm D: 1220mm H: 100mm
W: 48.03" D: 48.03" H: 3.94"
1 Box: 2 pcs.
1 Box: 2.84m² / 31sqft
1 Color of choice per package
Gross weight: 10.5Kg - 23.15 lbs

MATERIAL

Mechanical needled punch industrial felt. 100% PET up to 60% Recycled content & Recyclable

SOUND ABSORPTION

NRC Value 0.90 (ISO 11654)

FIRE RATING

A Class (ASTM E84) - B s1 d0 (EN 13501-1)

THERMAL INSULATION

0.035 W/mK

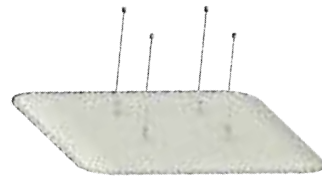

Product Code: FRL-30HG-BEG1091

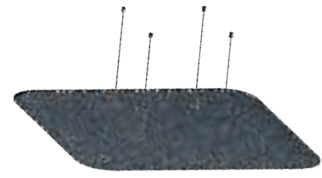

Product Code: FRL-30HG-DGR2061

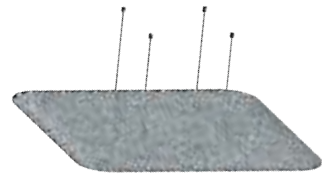

Product Code: FRL-30HG-GRY2011

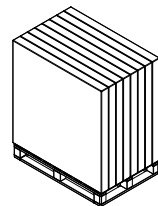
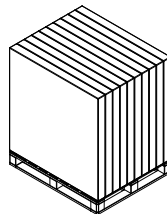

PALETTE SIZES & CONTENT

W: 1200mm D: 1000mm H: 1400mm W: 48" D: 40" H: 55"	W: 1200mm D: 800mm H: 1400mm W: 48" D: 31,5" H: 55"
1 Palette: 10 Pcs. Box	1 Palette: 8 Pcs. Box
Gross weight: 120Kg - 265 lbs	Gross weight: 96Kg - 212 lbs

Oblong Large

1200mm x 1800mm

APPLICATION

Internal Acoustic Control & Decorative Ceiling Pendant
Suspended With Adjustable Hanging Sets
4 pcs. Set Is Supplied For Each Unit

DIMENSIONS

W: 1200mm (+/- 1mm) - L: 1800mm (+/- 1mm)
W: 47.24" (+/-0.05") - L: 70.87" (+/-0.05")

THICKNESS



Max. 40mm (+/- 2mm) - 1.57" (+/-0.08")
Edge 8mm (+/- 2mm) - 0.31" (+/-0.08")

Smooth Surface - Impact Resistance - Flexible

WEIGHT

1 tile: 6550gr. +/- 10% tolerance
1 tile: 14.48 lbs with +/- 10% tolerance
(without hanging sets)

BOX SIZE & CONTENT

W: 1220mm D: 1820mm H: 100mm
W: 48.03" D: 71.65" H: 3.94"
1 Box: 2 pcs.
1 Box: 4.28m² / 46.5sqft
1 Color of choice per package
Gross weight: 15.7Kg - 34.5 lbs

MATERIAL

Mechanical needled punch industrial felt. 100% PET up to 60% Recycled content & Recyclable

SOUND ABSORPTION

NRC Value 0.90 (ISO 11654)

FIRE RATING

A Class (ASTM E84) - B s1 d0 (EN 13501-1)

THERMAL INSULATION

0.035 W/mK

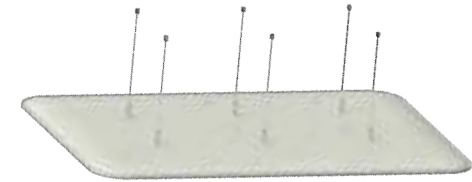

Product Code: OBL-40HG-BEG1091

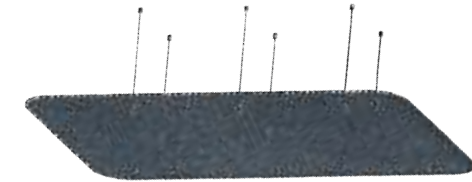

Product Code: OBL-40HG-DGR2061

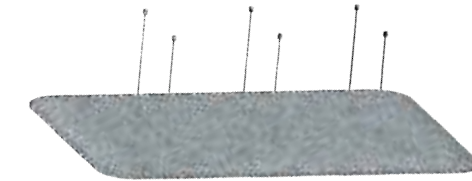

Product Code: OBL-40HG-GRY2011

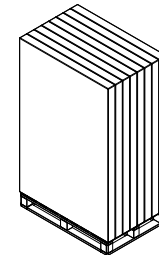
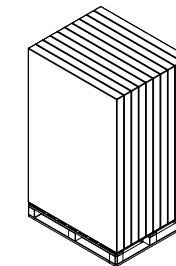

PALETTE SIZES & CONTENT

W: 1200mm D: 1000mm H: 2000mm W: 48" D: 40" H: 78.74"	W: 1200mm D: 800mm H: 2000mm W: 48" D: 31,5" H: 78.74"
1 Palette: 10 Pcs. Box	1 Palette: 8 Pcs. Box
Gross weight: 172Kg - 380 lbs	Gross weight: 138Kg - 304 lbs

The "Blade Small", "Blade Medium" and "Blade Large" are acoustic ceiling pendants

Blade Small

300mm x 900mm

APPLICATION

Internal Acoustic Control & Decorative Ceiling Pendant
Suspended With Adjustable Hanging Sets
2 pcs. Set Is Supplied For Each Unit

DIMENSIONS

W: 300mm (+/- 1mm) L: 900mm (+/- 1mm)
W: 11.81" (+/-0.05") L: 35.43" (+/-0.05")

THICKNESS



Max. 30mm (+/- 2mm) - 1.18" (+/-0.08")
Edge 8mm (+/- 2mm) - 0.31" (+/-0.08")

Smooth Surface - Impact Resistance - Flexible

WEIGHT

1 tile: 560gr. +/- 10% tolerance
1 tile: 1.24 lbs with +/- 10% tolerance
(without hanging sets)

BOX SIZE & CONTENT

W: 920mm D: 920mm H: 100mm
W: 36.22" D: 36.22" H: 3.94"
1 Box: 12 x Pendants
1 Box: 3m² / 34.88sqft
1 Color of choice per package
Gross weight: 8.5Kg - 18.7 lbs

MATERIAL

Mechanical needled punch industrial felt. 100%
PET up to 60% Recycled content & Recyclable

SOUND ABSORPTION

NRC Value 0.90 (ISO 11654)

FIRE RATING

A Class (ASTM E84) - B s1 d0 (EN 13501-1)

THERMAL INSULATION

0.035 W/mK



Product Code: BLDS-10HG-BEG1091



Product Code: BLDS-10HG-DGR2061

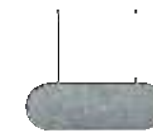

Product Code: BLDS-10HG-GRY2011

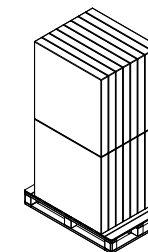
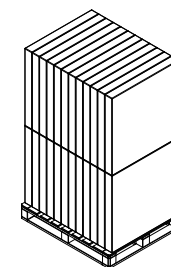

PALETTE SIZES & CONTENT

W: 1200mm D: 1000mm H: 2100mm W: 48" D: 40" H: 82"	W: 1200mm D: 800mm H: 2100mm W: 48" D: 31,5" H: 82"
1 Palette: 24 Pcs. Box	1 Palette: 16 Pcs. Box
Gross weight: 100Kg - 221 lbs	Gross weight: 80Kg - 177 lbs



Beige 1091

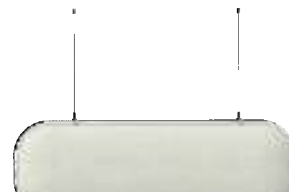

Dark Grey 2061

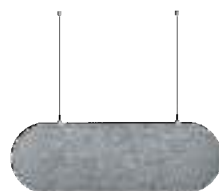
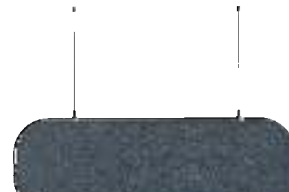

Grey 2011

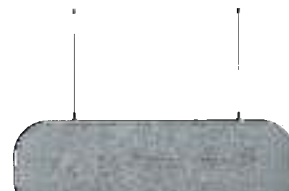
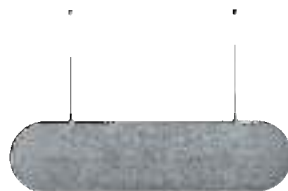

Blade Medium

300mm x 1200mm

APPLICATION

Internal Acoustic Control & Decorative Ceiling Pendant
Suspended With Adjustable Hanging Sets
2 pcs. Set Is Supplied For Each Unit

DIMENSIONS

W: 300mm (+/- 1mm) - L: 1200mm (+/- 1mm)
W: 11.81" (+/-0.05") - L: 47.24" (+/-0.05")

THICKNESS



Max. 30mm (+/- 2mm) - 1.18" (+/-0.08")
Edge 8mm (+/- 2mm) - 0.31" (+/-0.08")

Smooth Surface - Impact Resistance - Flexible

WEIGHT

1 tile: 760gr. +/- 10% tolerance
1 tile: 1.68 lbs with +/- 10% tolerance
(without hanging sets)

BOX SIZE & CONTENT

W: 1220mm D: 1220mm H: 100mm
W: 48.03" D: 48.03" H: 3.94"
1 Box: 12 pcs.
1 Box: 4.08m² / 46.50sqft
1 Color of choice per package
Gross weight: 10.9Kg - 24 lbs

MATERIAL

Mechanical needled punch industrial felt. 100%
PET up to 60% Recycled content & Recyclable

SOUND ABSORPTION

NRC Value 0.90 (ISO 11654)

FIRE RATING

A Class (ASTM E84) - B s1 d0 (EN 13501-1)

THERMAL INSULATION

0.035 W/mK

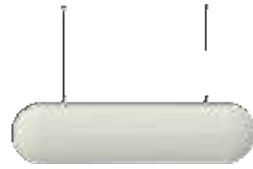

Product Code: BLDM-10HG-BEG1091

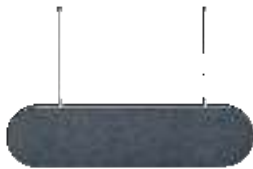

Product Code: BLDM-10HG-DGR2011

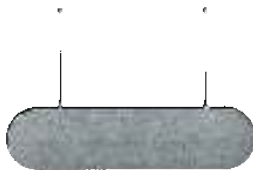

Product Code: BLDM-10HG-GRY2011

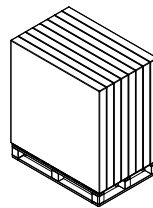
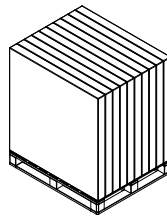

PALETTE SIZES & CONTENT

W: 1200mm D: 1000mm H: 1400mm W: 48" D: 40" H: 55"	W: 1200mm D: 800mm H: 1400mm W: 48" D: 31,5" H: 55"
1 Palette: 10 Pcs. Box	1 Palette: 8 Pcs. Box
Gross weight: 124Kg - 274 lbs	Gross weight: 100Kg - 220 lbs

Blade Large

400mm x 1200mm

APPLICATION

Internal Acoustic Control & Decorative Ceiling Pendant
Suspended With Adjustable Hanging Sets
4 pcs. Set Is Supplied For Each Unit

DIMENSIONS

W: 400mm (+/- 1mm) - L: 1200mm (+/- 1mm)
W: 15.75" (+/-0.05") - L: 47.24" (+/-0.05")

THICKNESS



Max. 30mm (+/- 2mm) - 1.18" (+/-0.08")
Edge 8mm (+/- 2mm) - 0.31" (+/-0.08")

Smooth Surface - Impact Resistance - Flexible

WEIGHT

1 tile: 1030gr. +/- 10% tolerance
1 tile: 2.28 lbs with +/- 10% tolerance
(without hanging sets)

BOX SIZE & CONTENT

W: 1220mm D: 1220mm H: 100mm
W: 48.03" D: 48.03" H: 3.94"
1 Box: 9 pcs.
1 Box: 4.14m² / 46.5sqft
1 Color of choice per package
Gross weight: 11Kg - 24.3 lbs

MATERIAL

Mechanical needled punch industrial felt. 100%
PET up to 60% Recycled content & Recyclable

SOUND ABSORPTION

NRC Value 0.90 (ISO 11654)

FIRE RATING

A Class (ASTM E84) - B s1 d0 (EN 13501-1)

THERMAL INSULATION

0.035 W/mK

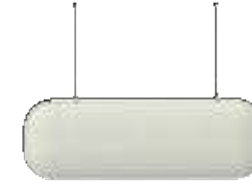

Product Code: BLDL-20HG-BEG1091



Product Code: BLDL-20HG-DGR2061



Product Code: BLDL-20HG-GRY2011

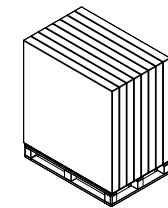
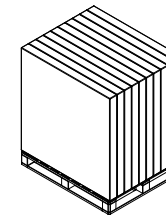

PALETTE SIZES & CONTENT

W: 1200mm D: 1000mm H: 1400mm W: 48" D: 40" H: 55"	W: 1200mm D: 800mm H: 1400mm W: 48" D: 31,5" H: 55"
1 Palette: 10 Pcs. Box	1 Palette: 8 Pcs. Box
Gross weight: 126Kg - 277 lbs	Gross weight: 101Kg - 222 lbs

Wall Panel - Plaid, Ridge, Bold

Plaid



Ridge



Bold



Wall Panel - Moon, Saturn, Venus

Moon



Saturn



Venus



Wall Panel - Zig, Zag, Corner, Central, Cross

Zig



Zag



Corner



Central



Cross



Wall Panel - Hex-One

Hex-One



Wall Panel - Woodie

Woodie Small



Wall Panel - Striped Large

Striped Large

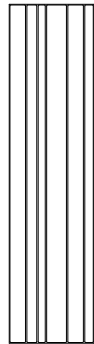

Drop-In Ceiling Tile - Cross

Cross Drop-In



Ceiling Pendant

Rotund, Small, Medium & Large

Rotund Small



Rotund Medium

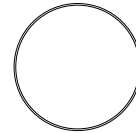

Rotund Large

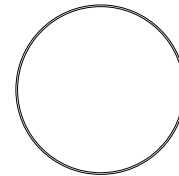

Ceiling Pendant

Oblong Small, Frame Large & Oblong Large

Oblong Small



Frame Large

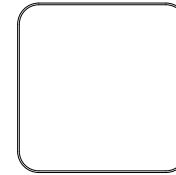

Oblong Large



Ceiling Pendant

Blade Small, Blade Medium & Blade Large

Blade Small

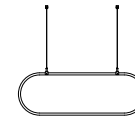

Blade Medium

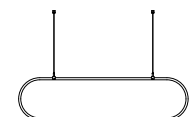

Blade Medium

